

# Installation Guide

CT22xxx, CT44xxx, BT22xxx and BT44xxx  
Telescopic ceiling mount

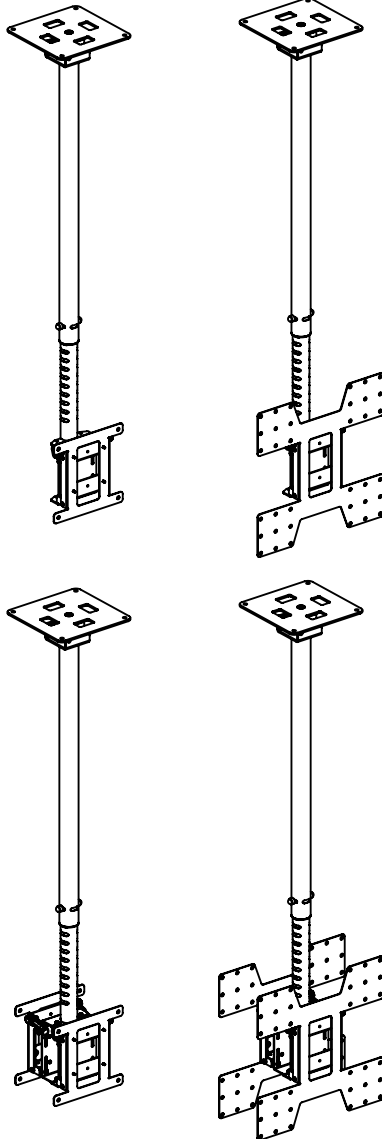



# CAUTION

- This product must be installed by a professional installer. It is recommended that more than one person is involved in the installation of this product.
- This product is designed to be ceiling mounted. Before installing please verify that the ceiling can bear the combined weight of the solution and hardware.
- The maximum weight limit for this product is 150 kg per ceiling pole. Do not exceed the stated weight limits.
- It is the responsibility of the installer to use the correct fixings for the specific installation location. Standard fixings for wooden material and fixings for concrete material are supplied as part of the product, but they will not be suitable for all types of ceilings.
- This product is intended for indoor use only.
- If these installation instructions are not followed precisely, it could lead to product failure and potential personal injury.
- Ergonomic Solutions / SpacePole inc. cannot be held responsible for any failure or injury, if the installation instructions are not followed correctly

# Tool list

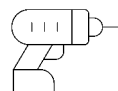
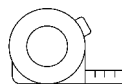
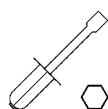
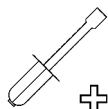
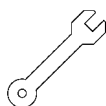
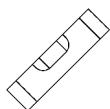

# Box content

CT2210AA

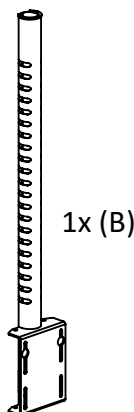
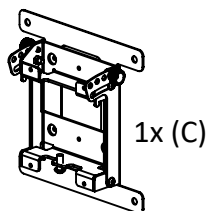
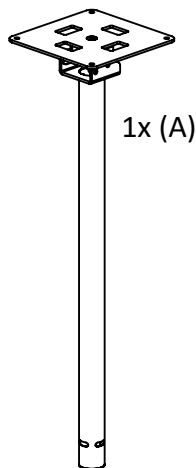

1x

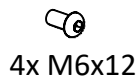

MK10-0076

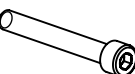

# Tool list

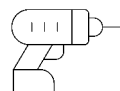
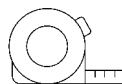
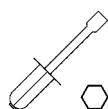
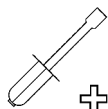
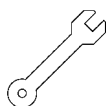
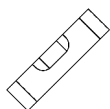

# Box content

BT2220AA

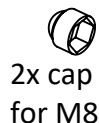
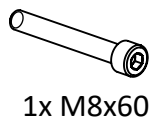
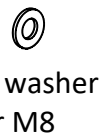
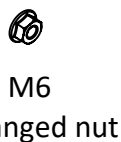
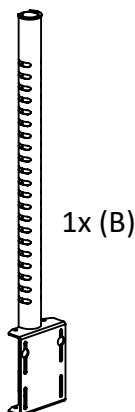
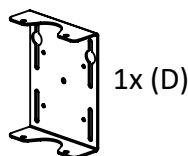
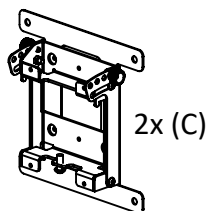
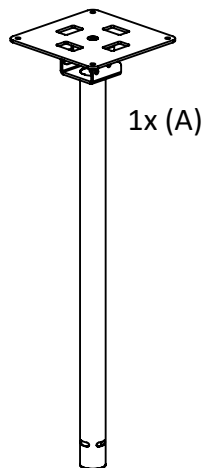

2x



MK10-0076

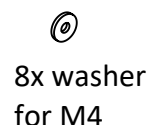
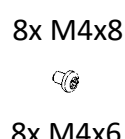
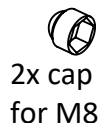
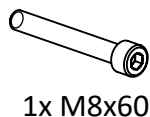
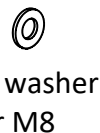

# Tool list

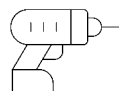
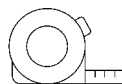
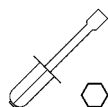
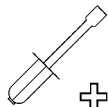
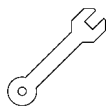
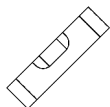

# Box content

CT4410AA

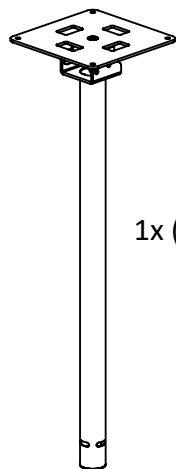

1x (A)

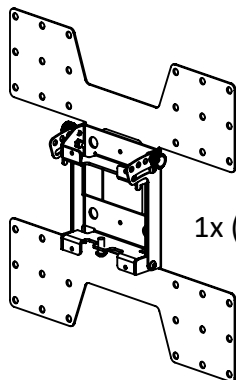

1x (C)

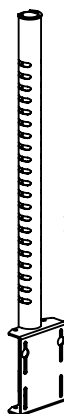

1x (B)

1x



4x M8x35



4x M8x16



4x M8x25



4x M6x12



4x washer  
for M8



4x spacer  
(5mm) for M8

MK10-0076



1x washer  
for M8



4x M4x12



4x M4x8



4x M4x6



1x M8  
lock nut

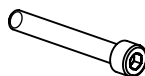

1x M8x60



4x washer  
for M4



2x cap  
for M8



4x M6x8

# Tool list

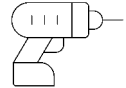
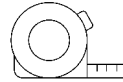
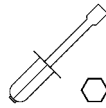
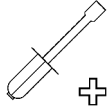
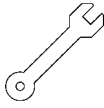
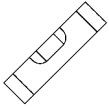

# Box content

BT4420AA

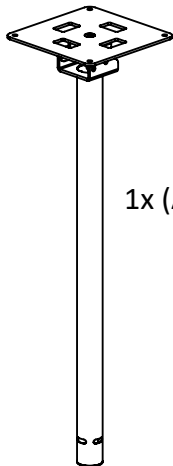

1x (A)

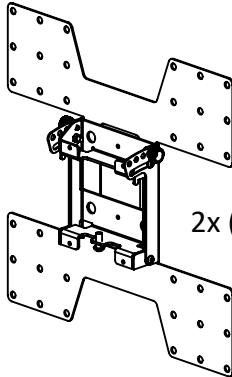

2x (C)

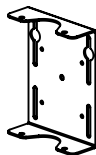

1x (D)

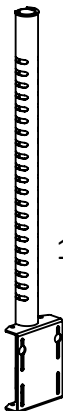

1x (B)

2x



4x M8x35



4x M8x16



4x M8x25



4x M6x12



4x washer  
for M8



4x spacer  
(5mm) for M8

MK10-0076



1x washer  
for M8



8x M4x12



8x M4x8



8x M4x6



1x M8  
lock nut

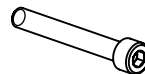

1x M8x60



8x washer  
for M4



4x M6x12



2x cap  
for M8



4x M6  
flanged nut



8x M6x8

# Dimensions [mm]

CT2210AA

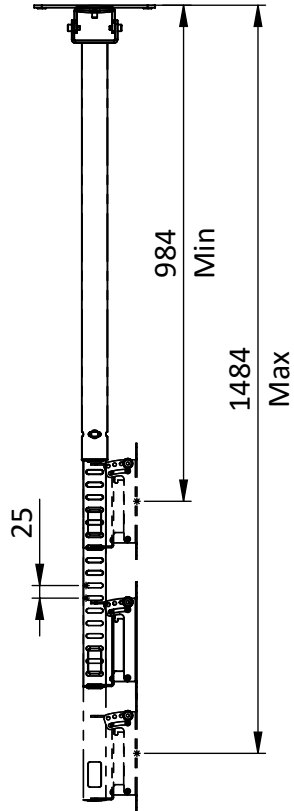
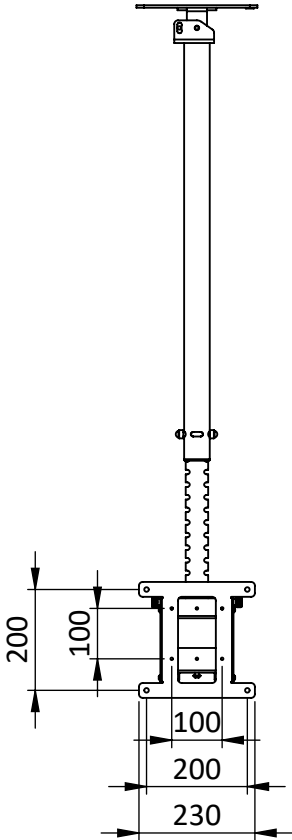
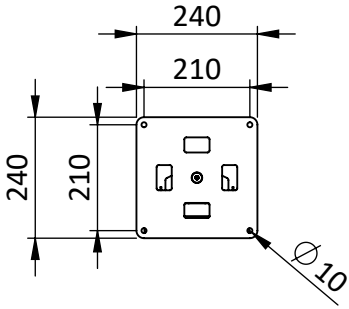

Min/ Max measured to middle of VESA.

# Dimensions [mm]

BT2220AA

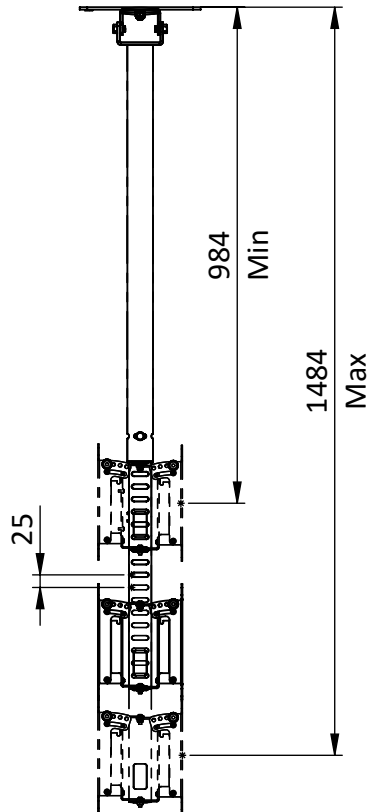
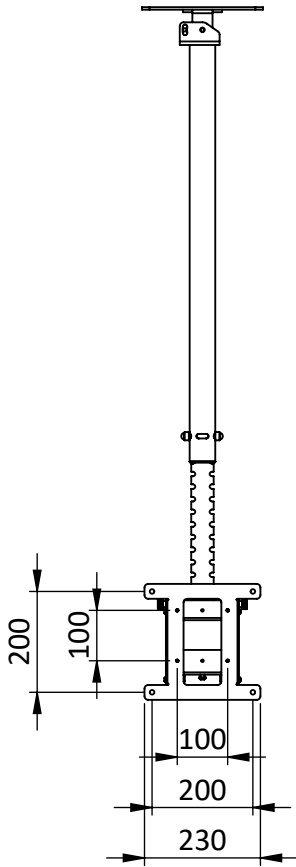
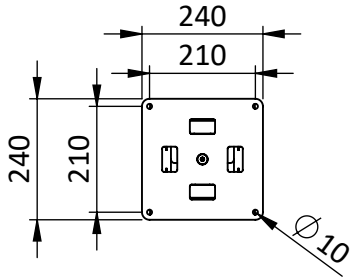

Min/ Max measured to middle of VESA.



# Dimensions [mm]

CT4410AA

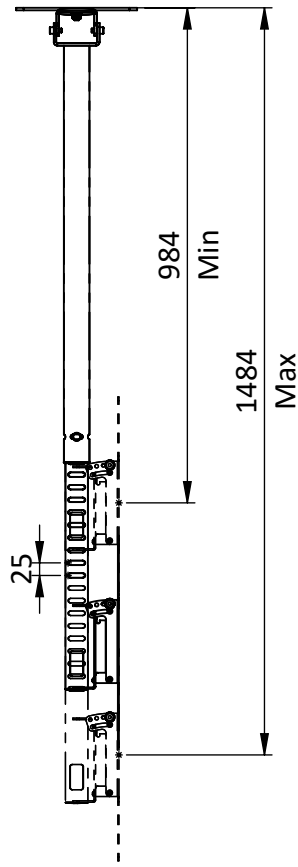
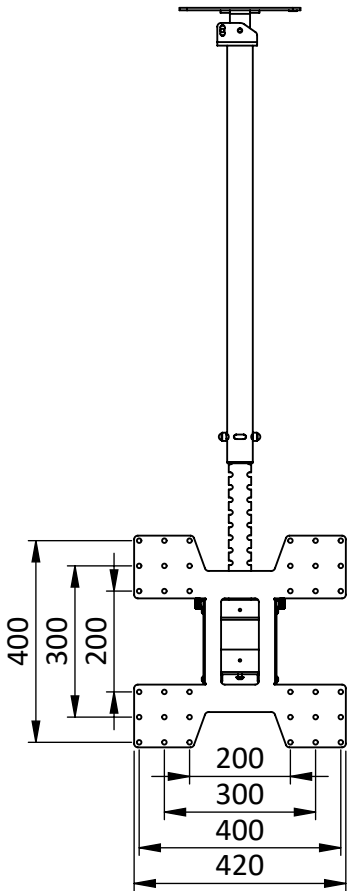
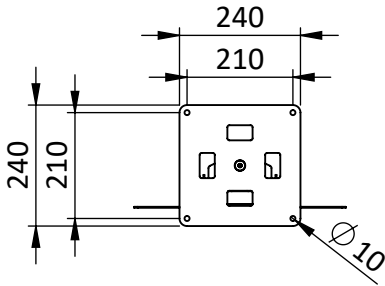

Min/ Max measured to middle of VESA.

# Dimensions [mm]

BT4420AA

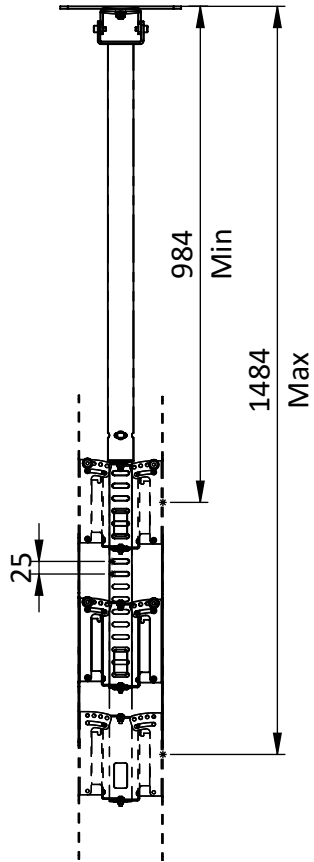
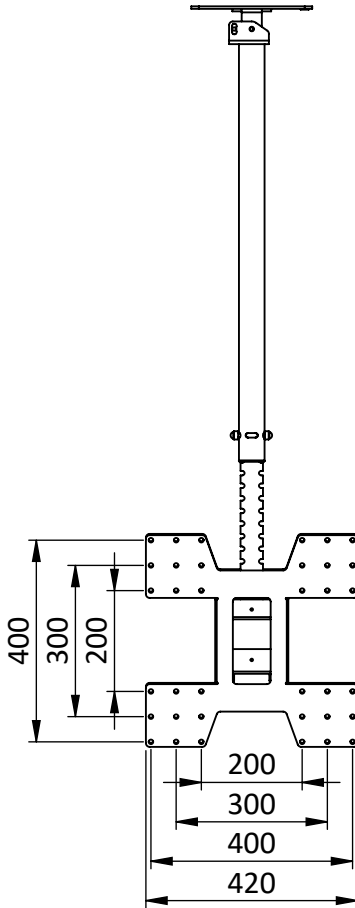
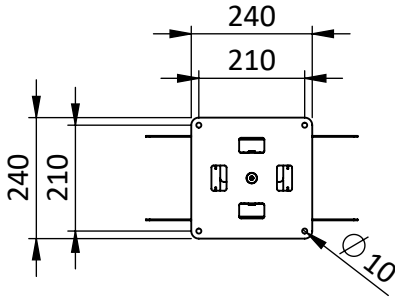

Min/ Max measured to middle of VESA.

# Steps

## Step 1: Attach (A) to the ceiling

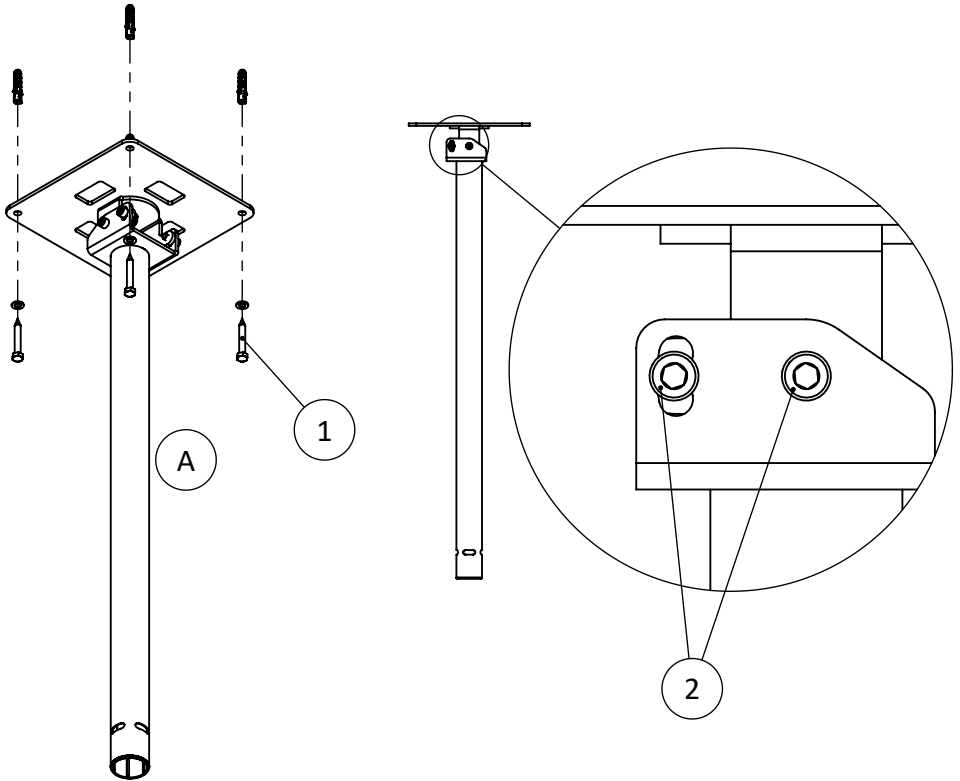

1 Use appropriate ceiling fixings to secure (A) to the ceiling

2 For fine adjustment, to align (A) vertically, loosen nuts, align and then tighten them to fix in position.

# Steps

Step 2: Route the cables

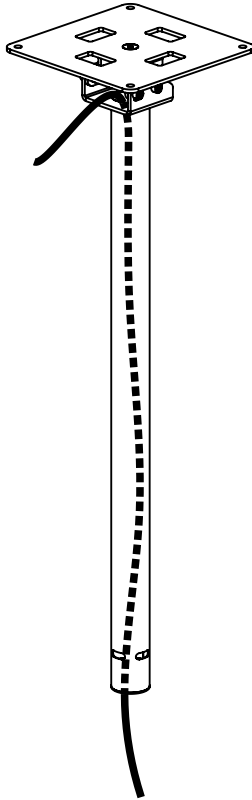

# Steps

## Step 3: Insert (B) and set position

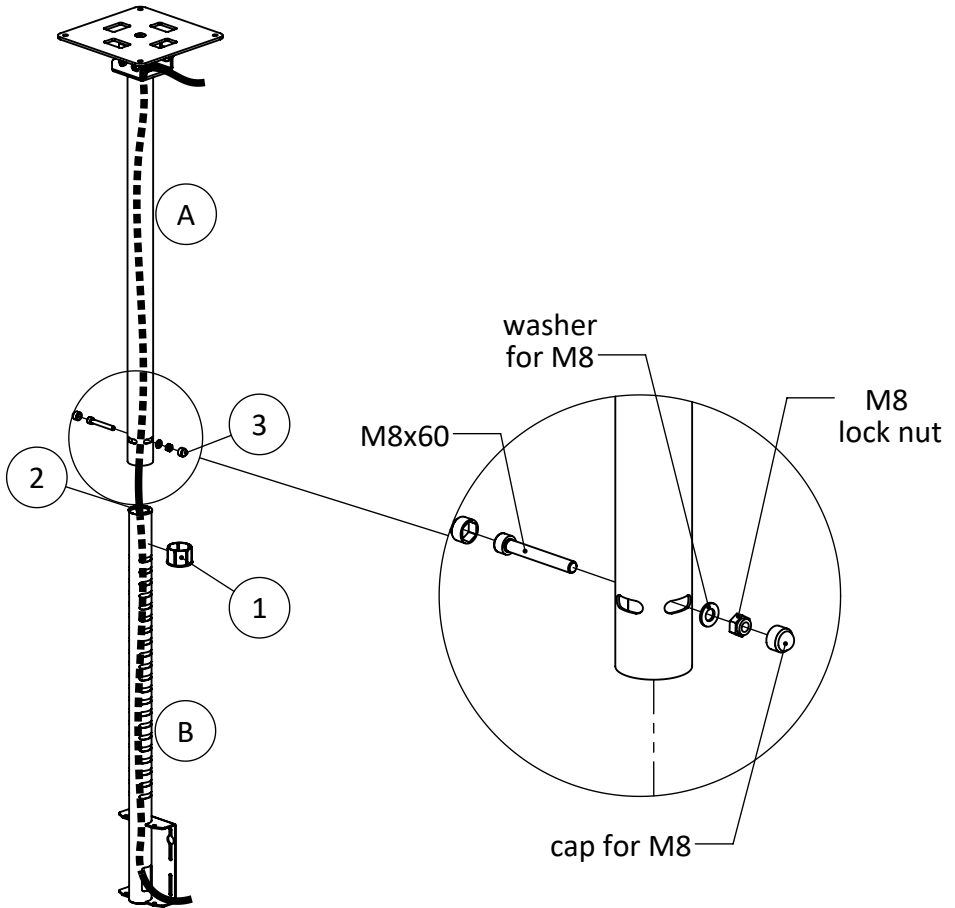

- 1 Make sure that the split sleeve is on (B)
- 2 Insert (B) in (A) and place at the desired height and orientation
- 3 Secure (B)

# Steps

## Step 4: Mount screen on adapter

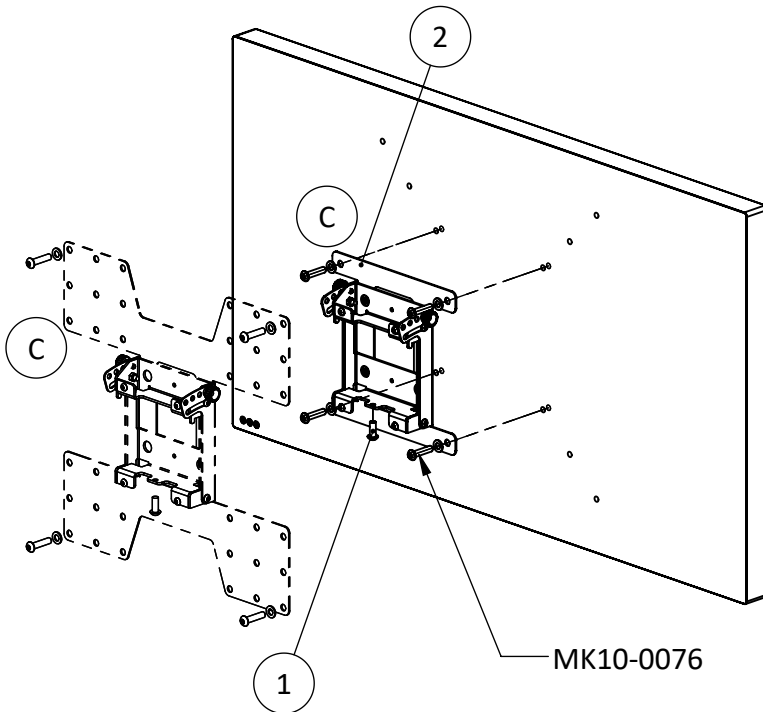

- 1 Remove screw from (C)
- 2 Use appropriate fixings to attach (C) to the screen

# Steps

## Step 5: Mount screen

Tilt options:

0 degrees

5 degrees

10 degrees

15 degrees

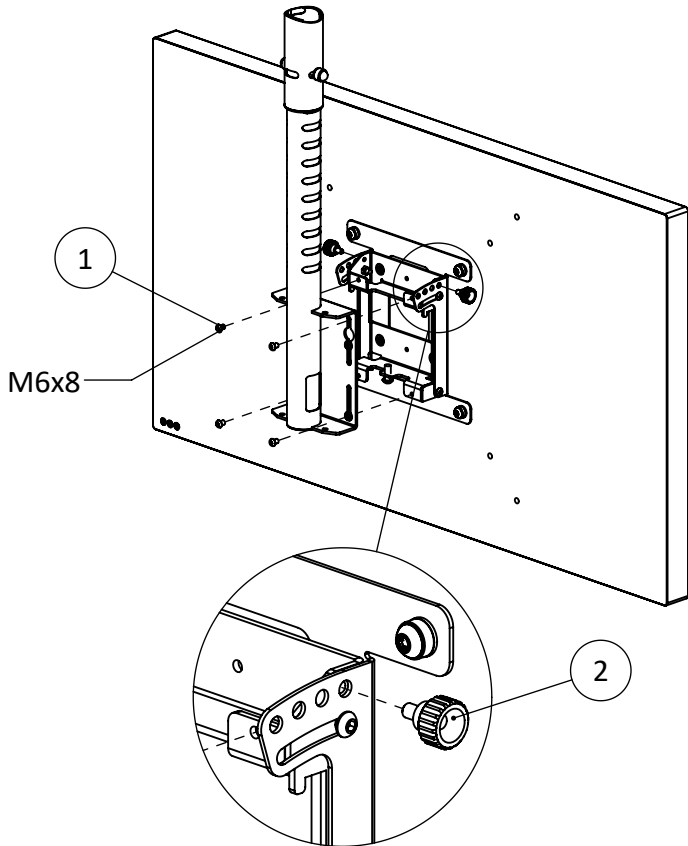

- 1 Mount the screen on the ceiling pole using 4x M6x8
- 2 Remove 2 x thumb screws and tilt to required angle, insert and tighten the thumb screws again

# Steps

**Step 6 (for BTxxx):** Mount back-to-back bracket.

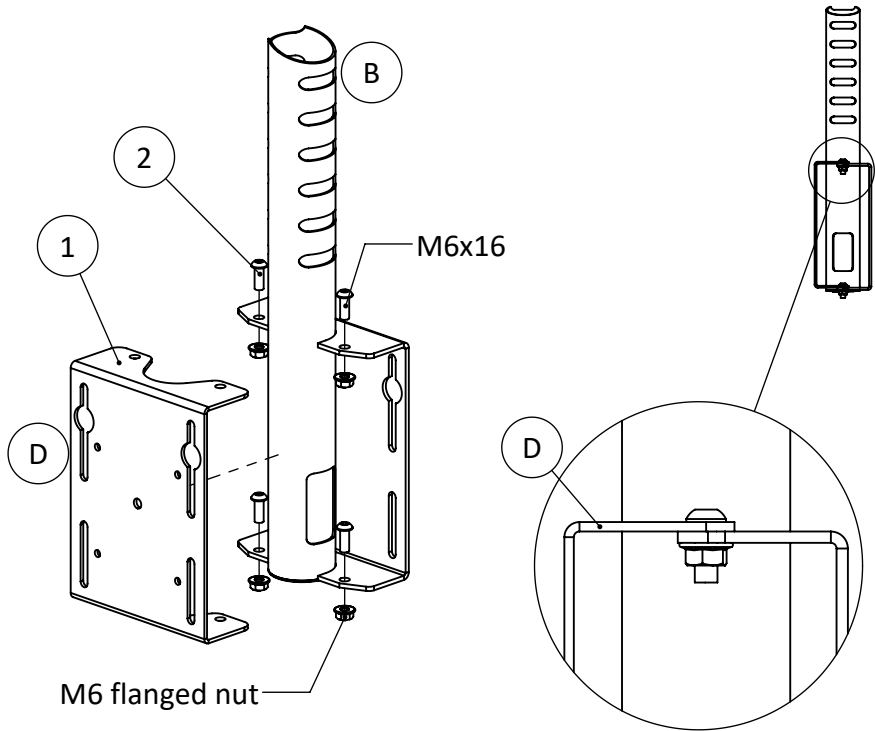

- 1 Align (D) with mounting holes on (B)
- 2 Secure (D) using M6 fixings



# Steps

## Step 7 (for BTxxx): Mount the second screen

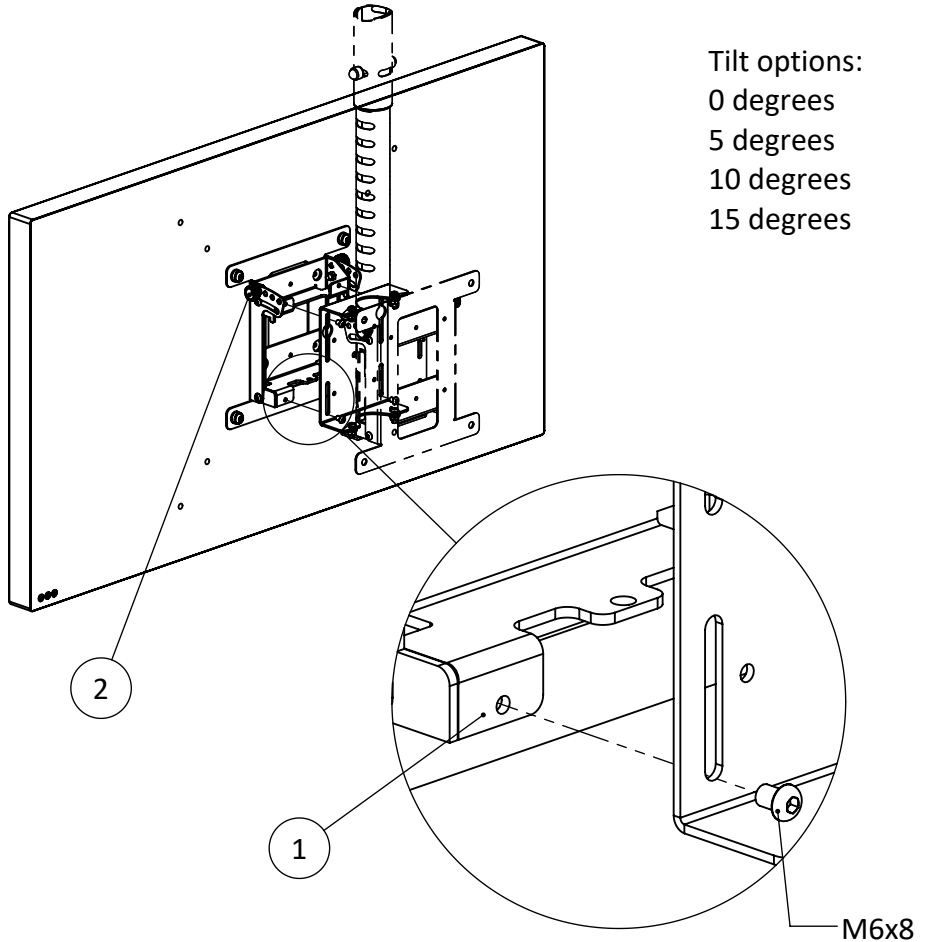

- 1 Mount the screen on the ceiling pole using 4x M6x8
- 2 Remove 2 x thumb screws and tilt to required angle, insert and tighten the thumb screws again (illustrated in Step 5)

*This page intentionally left blank*

*This page intentionally left blank*

**Need help? Contact us**



[ergonomic.solutions/about/contact-us](https://ergonomic.solutions/about/contact-us)

[spacepole.com/about/contact-us](https://spacepole.com/about/contact-us)